

P24L - CHASSIS MOUNT WITH LEAD WIRES, ISOLATION TRANSFORMER

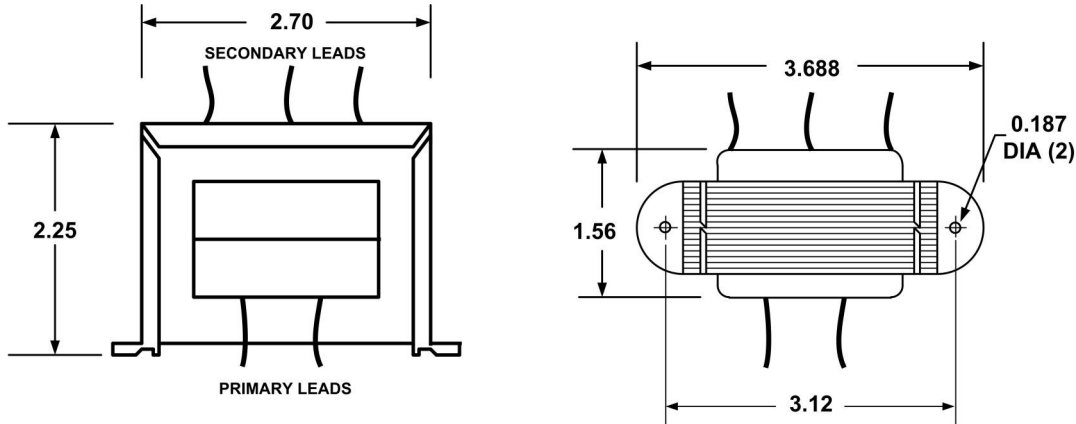

1. Electrical Specifications
 - A. Maximum Power: 36 VA
 - B. Input Voltage and Frequency: 24V @ 50/60Hz
 - C. Hi-Pot: 2500 Vrms 1 minute
2. Marking: Wabash Transformer, part number (see table), date code, terminal numbers
3. Agency Approval:
 - UL/cUL 5085-2 Recognized (File E47299)
 - Insulation File No. E95662



Part No.	Secondary 24V
P24L-36-24	24VCT @ 1.50A

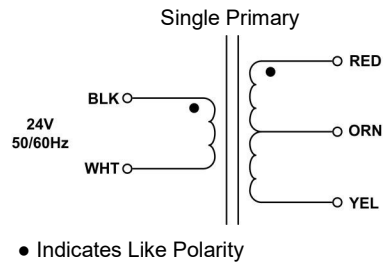

	ISOLATION TRANSFORMER	P24L-36-XX	
CONTENTS OF THIS DRAWING ARE SUBJECT TO CHANGE WITHOUT PRIOR NOTICE	Wabash Transformer 101 Industrial Park Drive, Clarence, IA 52216	Dim: Inches	Sheet 1 of 1
<small>PROPRIETARY NOTICE: THIS DRAWING PRINT OR DOCUMENT AND SUBJECT MATTER DISCLOSED HEREIN ARE PROPRIETARY ITEMS TO WHICH WABASH TRANSFORMER RETAINS THE EXCLUSIVE RIGHT OF DISSEMINATION, MANUFACTURE AND SALE. THIS DRAWING, PRINT OR DOCUMENT IS SUBMITTED IN CONFIDENCE FOR CONSIDERATION BY THE RECIPIENT ALONE UNLESS PERMISSION FOR FURTHER DISCLOSURE IS EXPRESSLY GRANTED IN WRITING</small>			